

JB SANITARY

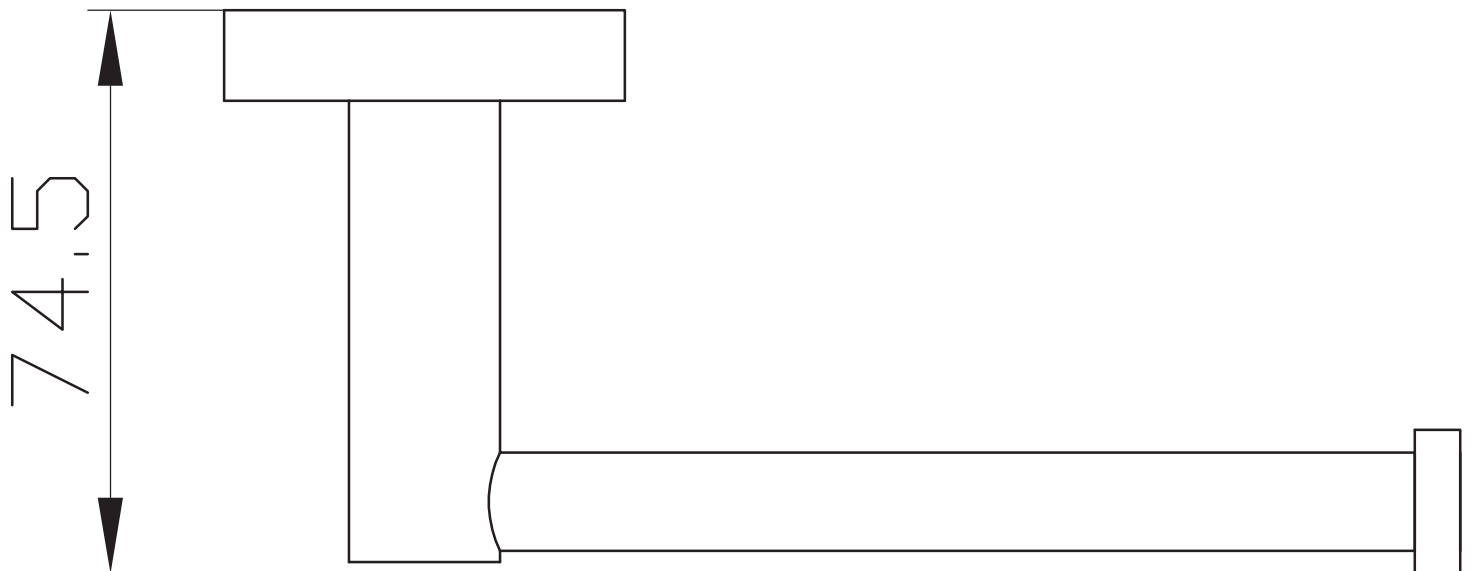
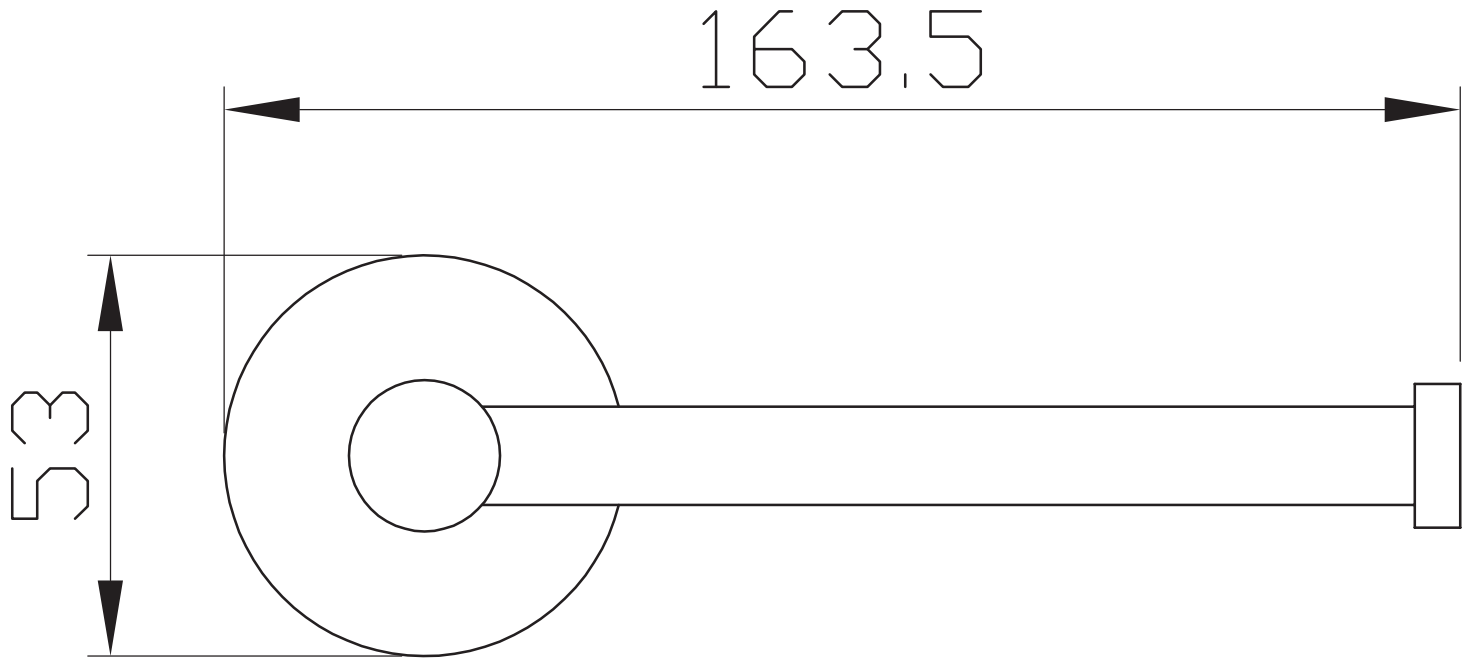

KB07 00